

**EnvironmentalLights.com Modular LED Dimmable Under Cabinet  
Lighting - 24 Volt DC**

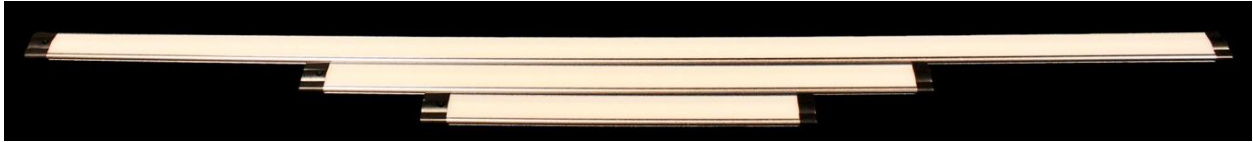

The UL Listed Modular LED Under Cabinet line from Environmental Lights is easy to install, dimmable, and provides great design flexibility. Perfect for brightening up functional work areas, kitchen counters, closets, display cabinets, anywhere extra light is needed! Utilize our Modular LED Under Cabinet line for smooth dimming and elegant diffused lighting, all in a thin package that fits in tight spaces just about anywhere you might need light.



This line includes 3 interchangeable configurations: Ultra Thin LED Light Bar, Angled LED Light Bar, and Surface Mount LED Puck. Products are available in two hues of white: soft (3,000°K) and neutral (4,000°K). We strongly recommend warm white, especially for residential use.

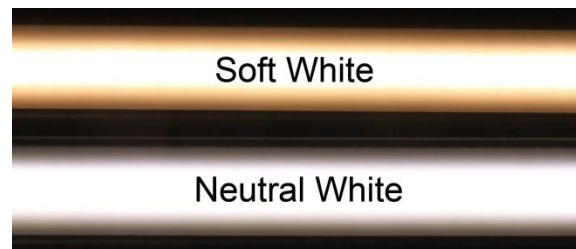

All Modular light products include built in diffusers to evenly distribute the light and eliminate hotspots, which is optimal when installing lights above reflective surfaces such as granite. Both Ultra Thin and Angled LED Under Cabinet Modular light bars have built in switches, for easy individual on/off control, and come in three lengths to fit your custom needs: 12, 20, and 40 inch.



## Features of the Modular LED Under Cabinet Light System

- Modular—it’s linkable and easy to connect and combine different pieces.
- Integrated milky diffuser on all lights provides uniform lighting.
- Light bars are easy to install and come with quick-mount clips and screws.
- Puck lights only require a single screw to mount, included.
- Dimmable and very energy efficient. LEDs are economical to operate and maintenance-free.
- Soft white bars create approximately 190 lumens per foot and the neutral white ones create 200 lumens per foot. Use cables or bar-to-bar connectors to add additional lights if required.

Lumens	Power Consumption	Soft White	Neutral White
Color Temperature		3,000°K	4,000°K
12 inch (300 mm)	3W	190	200
20 inch (500 mm)	5W	350	390
40 inch (1000 mm)	11W	680	780
Surface Mount Puck	3W	190	200

- The LED optics disperse the beam at 90 degrees, perfect for under cabinet lighting.
- Dims beautifully using compatible modular dimmers.
- Additional dimming options available when you use our UL-approved 48, 96 or 288 Watt 24 Volt DC Dimming Power Supply in combination with certain magnetic dimmers.
- No UV generated, so it’s safe for humans and objects, in general. Great for museums, displaying documents, artwork and other UV-sensitive subjects.
- No mercury to contaminate the environment upon disposal, unlike fluorescents.
- No ballast required, so no ballast to burn out and replace.
- Operating range: 0° - 100° F.
- Energy-efficient—saves around 85-90% versus incandescent light.
- No radio frequency interference, buzzing noise or flickering. Instant on.
- Lights have up to 50,000 hour lifetime, if properly driven and heat is allowed to escape.

## Applications

- Lighting functional task areas.
- Under cabinet lighting in kitchens, bathrooms, laundry rooms.
- Closets and pantries.
- Indirect cove lighting applications.
- Display cases, cubicles, work benches.
- Back lighting signs, down lighting and up lighting architectural features.
- Hotels, office buildings, homes, casinos, wine cellars, yachts, home theaters

## Getting Started: Creating Your Custom Modular Light System

This new series of UL Listed Modular LED Under Cabinet lighting is the new standard for excellent value in LED under cabinet lighting. Easy plug-and-play technology with soft diffused lighting, natural color, flawless dimming performance and interchangeable accessories—these modular light bars and pucks have it all. Compare our prices against other LED under cabinet lighting, and you'll know why our under cabinet lighting is so popular. Build your custom light installation with any combination of modular lights!

Use our top quality Modular LED Under Cabinet Lighting in kitchens, dens, entertainment centers, laundry rooms, closets—anywhere you want great light in a tight space. They're easy to wire, bright and dimmable, too! They barely use any power, so you'll save on electricity costs.

The Ultra Thin LED bars will hide behind the lip of almost any cabinet facing because they're only 0.3 inches thick, including the mounting clip. These products are much thinner than conventional under cabinet lighting and will fit places no fluorescent or xenon can. LEDs also run much cooler than xenon or halogen so you don't have to worry about heat.

Handy connectors are available to link and extend your system. We have the power and special extension cords you need to make your installation as large as you want.

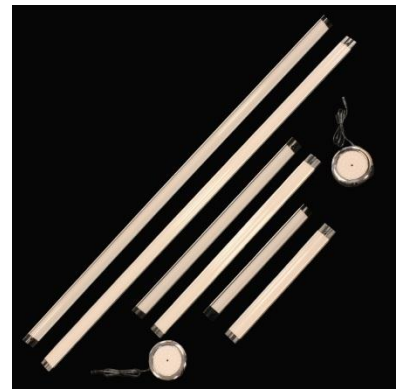

Dimming your modular lights is easy and inexpensive with the compatible power supply and dimmers designed specifically for this lighting system. We recommend using the UL listed 36 Watt 24 VDC Power Supply for Modular Under Cabinet lights, along with the compatible dimming accessories. Or, you can select a 48, 96 or 288 watt 24 Volt DC Dimming Power Supply for a fully scalable solution that can be used to customize larger installations in retail stores and other locations.

It's easier than you probably think to create eye-catching LED lighting projects. We have all the connectors, dimmers and power supplies you need—and this document shows you exactly how to build a system that works great.

We've helped thousands of people design with linear LED light, and they've used our under cabinet lights, ribbon flex and strips to make projects involving bars, restaurants, hotels, casinos, entertainment centers, indirect cove lighting, trade show booths, home theaters, wine cellars, yachts and cruise ships.

## Getting Started: Choose Your Modular Lights

Our Modular LED Under Cabinet line includes 3 interchangeable configurations: Ultra Thin LED Light Bar, Angled LED Light Bar, and Surface Mount LED Puck.

Each Puck Light comes with one screw. Modular light bars include several accessories, including:

- 2 mounting clips and screws (3 mounting clips and screws with the 40 inch);
- 1 40 inch male to male connector cord, to connect to a nearby bar;
- 1 straight bar to bar connector, for linking bars end to end.

Power supply and dimming accessories are NOT included.

Ultra Thin Under Cabinet Light Bars: 12, 24, and 40 inches



Angled Under Cabinet Light Bars: 12, 24, and 40 inches



Surface Mount Puck Light:



The bars are easy to connect and the mounting brackets snap in place for easy installation.

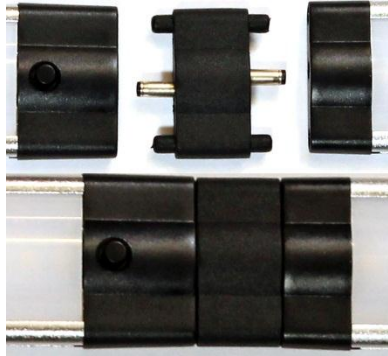

Description	Part Number
<b>Ultra Thin LED Lights</b>	
Modular Ultra Thin LED Under Cabinet Light with Diffuser and Switch, 12 inch Soft White	mod-t-sw12
Modular Ultra Thin LED Under Cabinet Light with Diffuser and Switch, 20 inch Soft White	mod-t-sw20
Modular Ultra Thin LED Under Cabinet Light with Diffuser and Switch, 40 inch Soft White	mod-t-sw40
Modular Ultra Thin LED Under Cabinet Light with Diffuser and Switch, 12 inch Neutral White	mod-t-nw12
Modular Ultra Thin LED Under Cabinet Light with Diffuser and Switch, 20 inch Neutral White	mod-t-nw20
Modular Ultra Thin LED Under Cabinet Light with Diffuser and Switch, 40 inch Neutral White	mod-t-nw40
<b>Angled LED Lights</b>	
Modular Angled LED Under Cabinet Light with Diffuser and Switch, 12 inch Soft White	mod-t-sw12
Modular Angled LED Under Cabinet Light with Diffuser and Switch, 20 inch Soft White	mod-t-sw20
Modular Angled LED Under Cabinet Light with Diffuser and Switch, 40 inch Soft White	mod-t-sw40
Modular Angled LED Under Cabinet Light with Diffuser and Switch, 12 inch Neutral White	mod-a-nw12
Modular Angled LED Under Cabinet Light with Diffuser and Switch, 20 inch Neutral White	mod-a-nw20
Modular Angled LED Under Cabinet Light with Diffuser and Switch, 40 inch Neutral White	mod-a-nw40
<b>Surface Mount LED Puck Lights</b>	
Modular Surface Mount LED Puck Light with Diffuser, Soft White	mod-puck-sw
Modular Surface Mount LED Puck Light with Diffuser, Neutral White	mod-puck-nw

## Specifications: Modular Under Cabinet Light Bars

The Modular LED Under Cabinet Light Bars come in two styles: Ultra Thin and Angled. The Ultra Thin Under Cabinet Light Bars are sleek and low profile. At 0.3 inches (0.4 inches including the on/off switch), it is our slimmest bar yet! The Angled Modular Under Cabinet Bars are perfect for 90 degree corner installations and provide perfect lighting at an angle.



Ultra Thin Modular vs. High Brightness Dimmable LED Under Cabinet Bars



Ultra Thin vs. Angled Modular Under Cabinet Bars

### Modular Ultra Thin Bar

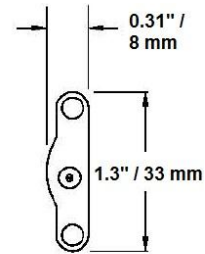
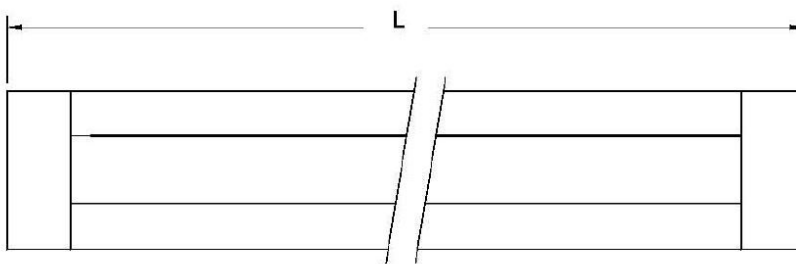

### Modular Angled Bar

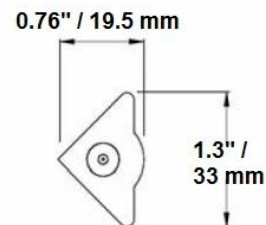
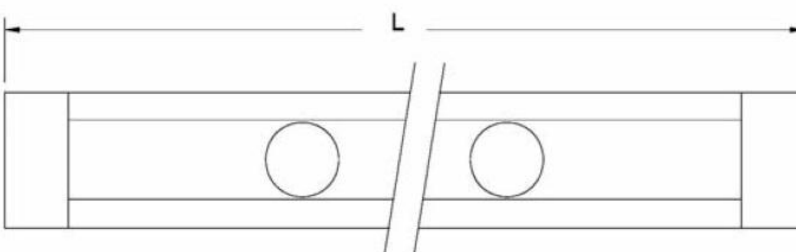



## Mounting

Each Ultra Thin or Angled Clip requires a single M2.6x10 screw.



## Setup

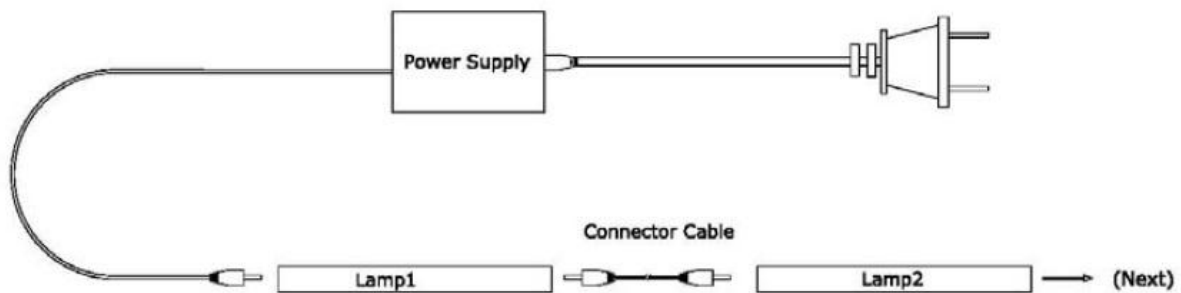

Use the connector cables to space your bars as much as needed.

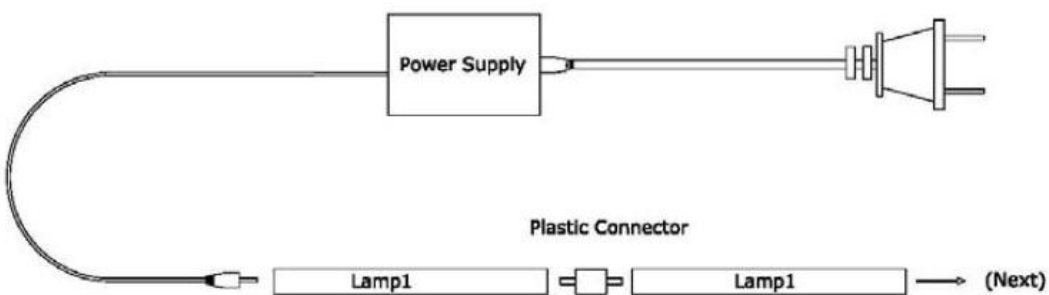

Or, use the bar-to-bar connectors to directly connect multiple light bars.

## Specifications: Modular Puck Lights

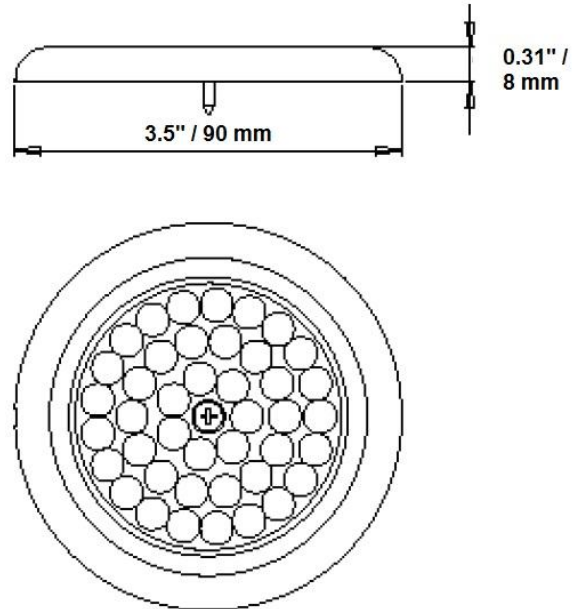

### Mounting

Each puck light requires a single M4x20 screw.

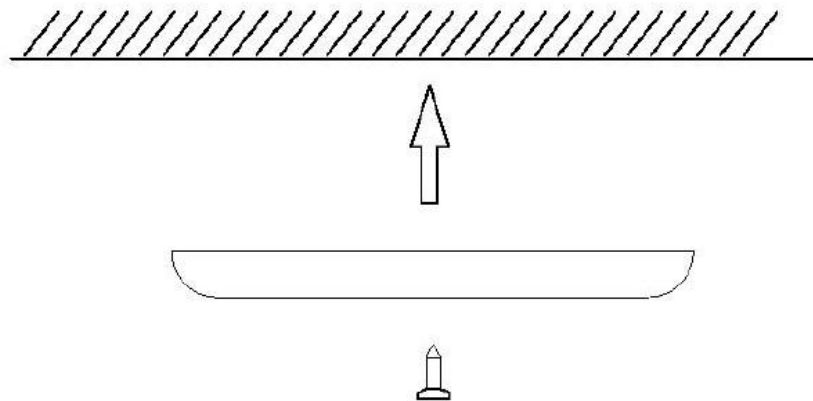



## Setup

Male-to-male connector must be used between each puck light and the splitter.

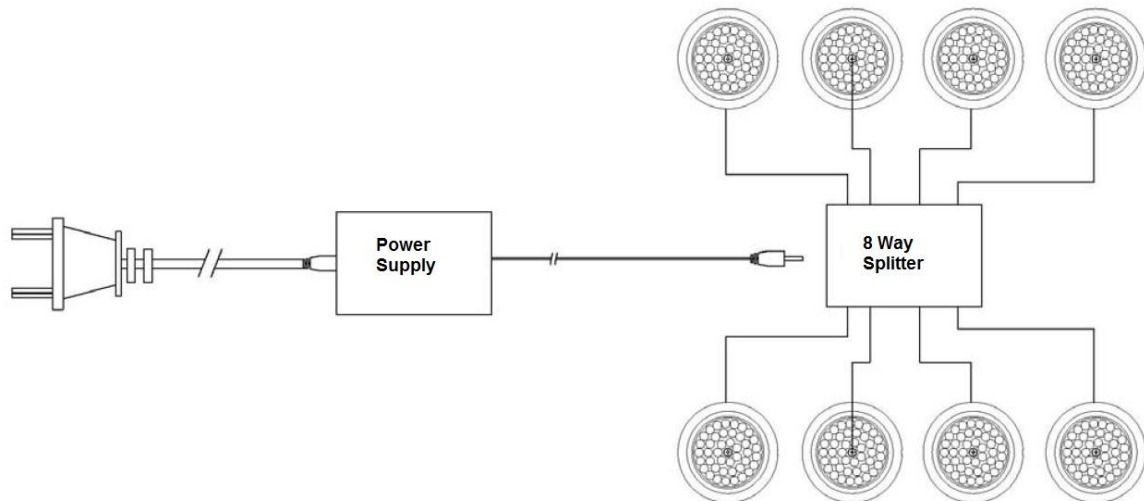

## Choose Your Accessories: Connectors and Splitters

Our Modular LED Under Cabinet line includes easy to use accessories such as connectors, cable extensions, splitters, in line dimmers, and touch dimmers. Pay close attention to the compatibility, as certain accessories are custom fit for select product.



Straight Bar-to-Bar Connector,  
for Ultra Thin Bars.



Corner Bar-to-Bar Connector,  
for Ultra Thin Bars.



Straight Bar-to-Bar Connector,  
for Angled Bars.

Connector cables can be used to link bars in various different orientations for additional light output. **The recommended branch length limit is 20 feet.** Splitters can be used to link multiple branches to a single power source. Due to their female input, a male-to-male cord must be used to connect each puck light or bar to the 4 or 8-way splitter.



4 Way Splitter



8 Way Splitter

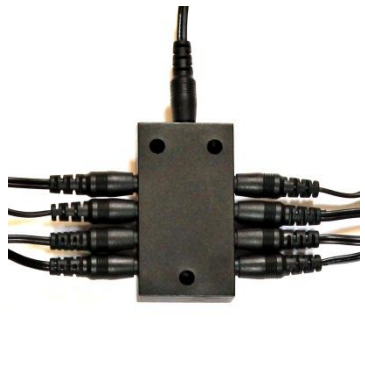

8-Way Splitter,  
connected.

**It doesn't matter which way you connect cord connectors—the light bars will accept either orientation.** We also offer a connector cord with bare wires on one end, so that you have bare wires to work with. The DC Junction Connector allows you to customize the wiring of your installation.



Male plug connected to  
Angled Light Bar.



Male plug connected to  
Ultra Thin Light Bar.



Low Voltage Connector Cord,  
Male-to-Bare Wires.



Low Voltage Connector Cord,  
male-to-male plug.

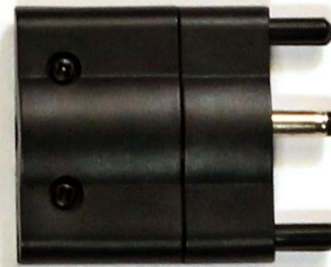

DC Junction Connector,  
for Ultra Thin Bars.

<b>Connectors and Splitters</b>	
Straight Bar-to-Bar Connector for Modular Ultra Thin LED Under Cabinet Light	mod-t-conn
Corner Bar-to-Bar Connector for Modular Ultra Thin LED Under Cabinet Light	mod-t-corner
Straight Bar-to-Bar Connector for Modular Angled LED Under Cabinet Light	mod-a-conn
4-Output Splitter for Modular Under Cabinet Lights	mod-split-4
8-Output Splitter for Modular Under Cabinet Lights	mod-split-8
Low Voltage Connect Cord, Male to Male Plug (4 inches long)	mod-cord-4
Low Voltage Connect Cord, Male to Male Plug (12 inches long)	mod-cord-12
Low Voltage Connect Cord, Male to Male Plug (24 inches long)	mod-cord-24
Low Voltage Connect Cord, Male to Male Plug (40 inches long)	mod-cord-40
Low Voltage Connect Cord, Male to Male Plug (78 inches long)	mod-cord-78
Low Voltage Connect Cord, Male to Bare Wires (78 inches long)	mod-cord-b-78
DC Junction Connector for Modular Ultra Thin LED Under Cabinet Light	mod-t-dc

**Choose Your Accessories:**

**Master Switch**

Use the master switch to control all of your Modular Ultra Thin LED Under Cabinet lights at the same time. Turn multiple bars on and off together. The master switch is only compatible with Modular Ultra Thin Under Cabinet Light Bars and will not fit into the Angled LED Under Cabinet Light.

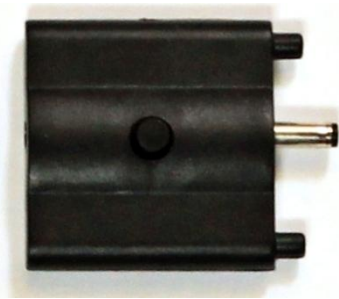

Master Switch,  
compatible with Ultra Thin Bar.

**Modular Dimmers**

The EnvironmentalLights.com Modular Under Cabinet Line includes two options for dimming and controlling bar and puck lights.



In Line Dimmer



Touch Dimmer,  
compatible with Ultra Thin Bar.

Dimmers and Switches	
Master Switch for Modular Ultra Thin LED Under Cabinet Light	mod-t-switch
In Line Dimmer for Modular Under Cabinet Lights	mod-dim
Touch Dimmer for Modular Ultra Thin LED Under Cabinet Light	mod-t-td

## Supplying Power

For easy plug-and-play installation, we recommend using the compatible UL listed 36 Watt 24 VDC Power Supply for Modular Under Cabinet Lights. The male output from the 36 Watt 24 VDC Power Supply can be plugged directly into the input on any of the Modular lights; or into a 4 or 8 way splitter.

During UL qualification and testing of the Modular Under Cabinet Lights, the modular lights and accessories were certified using only the 36 Watt 24 VDC Power Supply for Modular Under Cabinet Lights. If you require UL for your entire modular light system, we suggest using only the compatible UL listed modular companion parts and 36 Watt 24 VDC Power Supply.

Be sure not to overload your power supply. It is a good idea to allow around 20% margin for safety with power supplies for peak versus sustained power. Therefore, for the 36 Watt 24 VDC Power Supply we recommend designing your installation using no more than 29 watts of lights per power supply. For example, two 40 inch bars (11 watts each) and two 12 inch bars (3 watts each) would total 28 watts, an acceptable level. On the other hand, three 40 inch bars would total 33 watts, which is outside the recommended limit.

Description	Part Number
<b>Non-Dimming Supplies (Drivers)</b>	
<a href="#">36 Watt 24 VDC Power Supply for Modular Under Cabinet Lights</a>	mod-driver-36-24
<a href="#">35 Watt 24 VDC Waterproof Power Supply</a>	LPV-35-24
<a href="#">60 Watt 24 VDC Waterproof Power Supply</a>	LPV-60-24
<a href="#">100 Watt 24 VDC Waterproof Power Supply with PFC</a>	HLG-100H-24
<a href="#">150 Watt 24 VDC Power Supply with PFC</a>	SP-150-24
<a href="#">150 Watt 24 VDC Waterproof Power Supply with PFC</a>	HLG-150H-24
<a href="#">240 Watt 24 VDC Power Supply with PFC</a>	SP-240-24
<a href="#">240 Watt 24 VDC Waterproof Power Supply with PFC</a>	HLG-240H-24
<a href="#">312 Watt 24 VDC Power Supply with PFC</a>	SP-320-24
<a href="#">320 Watt 24 VDC Waterproof Power Supply with PFC</a>	HLG-320H-24
<a href="#">480 Watt 24 VDC Power Supply with PFC</a>	SP-480-24
<a href="#">750 Watt 24 VDC Power Supply with PFC</a>	SP-750-24

## Check List for Your Project

Here are the components you'll need. Be sure to check the compatibility of all accessories using the chart below.

### Light Bar(s) and Pucks:

Modular Ultra Thin LED Under Cabinet Light with Diffuser and Switch: 12, 20 and 40 inches.



Modular Angled LED Under Cabinet Light with Diffuser and Switch: 12, 20 and 40 inches.



Modular Surface Mount LED Puck Light with Diffuser





**Connector(s) or Splitter(s) (optional):**



**Master Switch (optional)**

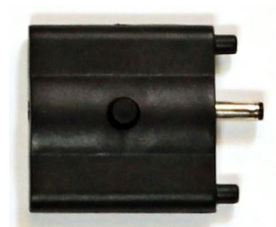

**Extra Clips and Screws (optional)**

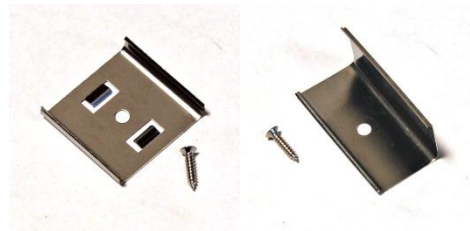

**Power Supply plus (optional) Dimmer, or**





## Dimming Supply and Dimmer:



<b>Accessory Compatibility Chart</b>	
Straight Bar-to-Bar Connector for Modular Ultra Thin LED Under Cabinet Light	Ultra Thin Bars
Corner Bar-to-Bar Connector for Modular Ultra Thin LED Under Cabinet Light	Ultra Thin Bars
Straight Bar-to-Bar Connector for Modular Angled LED Under Cabinet Light	Angled Bars
4-Output Splitter for Modular Under Cabinet Lights	All Modular Products
8-Output Splitter for Modular Under Cabinet Lights	All Modular Products
Low Voltage Connect Cord, Male to Male Plug (4 inches long)	All Modular Products
Low Voltage Connect Cord, Male to Male Plug (12 inches long)	All Modular Products
Low Voltage Connect Cord, Male to Male Plug (24 inches long)	All Modular Products
Low Voltage Connect Cord, Male to Male Plug (40 inches long)	All Modular Products
Low Voltage Connect Cord, Male to Male Plug (78 inches long)	All Modular Products
Low Voltage Connect Cord, Male to Bare Wires (78 inches long)	All Modular Products
DC Junction Connector for Modular Ultra Thin LED Under Cabinet Light	Ultra Thin Bars
Master Switch for Modular Ultra Thin LED Under Cabinet Light	Ultra Thin Bars
In Line Dimmer for Modular Under Cabinet Lights	All Modular Products
Touch Dimmer for Modular Ultra Thin LED Under Cabinet Light	Ultra Thin Bars
Straight Clip and Screw for Modular Ultra Thin LED Under Cabinet Light	Ultra Thin Bars
Angled Clip and Screw for Modular Angled LED Under Cabinet Light	Angled Bars

## Recommended Dimmers for Dimming Power Supply

When choosing to use a Dimming Power supply on your Modular Light System, we recommend only Magnetic Low Voltage dimmers. If you use one of the recommended MLV dimmers and corresponding compatible Dimming Power Supply listed below, your modular lights will dim beautifully! However, we are not responsible for damages if you use an incompatible dimming system. Read the guidance below and call if you have questions. Some dimmers, including home automation systems, will damage our dimming drivers.

**\*\*NOTE: Even though we tested and recommend the use of the dimmers and dimming power supplies listed below, during UL qualification and testing of the Modular Under Cabinet Lights, the modular light system was certified using only the 36 Watt 24 VDC Power Supply for Modular Under Cabinet Lights. If you require UL for your entire modular light system, we suggest using only the compatible modular companion parts and 36 Watt 24 VDC Power Supply discussed in the previous section.\*\***

Use Magnetic Low Voltage Dimmers only. Do not use incandescent, Electronic Low Voltage or LED/CFL dimmers.

During dimming testing we found that the **48 Watt 24 VDC Dimming Power Supply** worked best with the Leviton Sureslide (6613-PL), and Maestro Wireless (MRF2-6ND-120). When using the **96 Watt 24 VDC Dimming Power Supply**, we recommend the Lutron Diva (DVLV-603P), Skylark (SLV-603P), and Maestro Wireless (MRF2-6ND-120). When testing the Maestro Wireless dimmer the only variance that we noticed was slight flicker at the very bottom end.



Sureslide  
6613-PL



Skylark  
SLV-603P



Diva  
DVLV-603P

The Lutron Maestro Wireless Magnetic Low Voltage Dimmer (MRF2-6ND-120) is more expensive than the others, but affords wireless dimming, if you buy the companion part, the Pico Wireless Remote Control: PJ-3BRL-GWH-I01 or PJ-3BRL-GWH-T01. However, be sure to confirm that you have a neutral wire, as the Maestro Wireless Dimmer requires a neutral wire in the gang box to work.



Maestro Wireless MLV  
[MRF2-6ND-120](#)



Lutron Pico Wireless Control 3-Button  
 and Raise/Lower with icon engravings  
[PJ-3BRL-GWH-I01](#)



Lutron Pico Wireless Control 3-Button  
 and Raise/Lower with text engravings  
[PJ-3BRL-GWH-T01](#)



Wireless control sold separately  
 Lutron Pico Wireless Control  
 Single Pedestal  
[L-PED1-WH](#)



Wireless controls sold separately  
 Lutron Pico Wireless Control  
 Double Pedestal  
[L-PED2-WH](#)

The inline dimmers below are other handy ways of dimming our LED under cabinet lights if you prefer to use 24 Volt DC power instead of 120 Volt AC power. Note that the second dimmer says 8 amps, but we stipulate only 6 amps sustained power. EnvironmentalLights.com has tested all these dimmers and stipulated our own sustained maximum power ratings, which in some cases are below those of the manufacturer. Most other vendors don't bother to do this, which can cause dimmer failure. For more information, refer to the individual user manuals of each dimmer.



12 or 24 V LED Dimmer  
with Rotary Knob (White)  
[Dim1](#)



12 or 24 V LED Dimmer  
Rotary Knob (Almond)  
[Dim2](#)



24 V LED Dimmer with  
Remote Control (Black)  
[24VDim3](#)



IR Sensor End  
of device pictured below



12 or 24 V Mini  
LED Touch Dimmer  
[Dim8](#)



12 or 24 V Mini LED  
IR Sensor Switch  
[Sensor1](#)

<b>Dimming Supplies (Drivers) and Dimmers</b>	
<a href="#"><u>48 Watt 24 VDC Dimming Power Supply (120 VAC input)</u></a>	48W24VDim-120AC
<a href="#"><u>96 Watt 24 VDC Dimming Power Supply (120 VAC input)</u></a>	96W24VDim-120AC
<a href="#"><u>288 (3x96) Watt 24 VDC Dimming Power Supply (120 VAC input)</u></a>	3x96W24VDimX-120AC
<a href="#"><u>Leviton Sureslide Magnetic Dimmer; Single Pole or 3-Way (Multi-location)</u></a>	6613-PL
<a href="#"><u>Lutron Skylark Magnetic Low Voltage Dimmer; 450 Watt, Single Pole or 3-Way (Multi-location) White</u></a>	SLV-603P-WH
<a href="#"><u>Lutron Diva Magnetic Low Voltage Dimmer; 450 Watt, Single Pole or 3-Way (Multi-location)</u></a>	DVLV-603P
<a href="#"><u>Lutron Diva Magnetic Low Voltage Dimmer; 800 Watt, Single Pole or 3-Way (Multi-location) White</u></a>	DVLV-103P-WH
<a href="#"><u>Lutron Maestro Wireless Magnetic Low Voltage Dimmer (Spec. Grade); 450 Watt, Single Pole or Multi-location White</u></a>	MRF2-6ND-120-WH
<a href="#"><u>Pico wireless control, 434 MHz, 3-button with Raise/Lower with light icon engraving</u></a>	PJ-3BRL-GWH-I01
<a href="#"><u>Pico wireless control, 434 MHz, 3-button with Raise/Lower with light text engraving</u></a>	PJ-3BRL-GWH-T01
<a href="#"><u>12 or 24 V LED Dimmer with Rotary Knob (White)</u></a>	Dim1
<a href="#"><u>12 or 24 V LED Dimmer with Rotary Knob (Almond)</u></a>	Dim2
<a href="#"><u>24 V LED Dimmer with Remote Control (Black)</u></a>	24VDim3

## Instructions

Please take the following general precautions when installing any sort of LED lighting:

1. This equipment, like all electrical equipment, should be installed by a qualified person. You should have the basic tools and knowledge of the trade. If you do not, get help.
2. Never wire systems with the power on. Even if you take care not to hurt yourself, you may damage the LEDs or equipment by creating current spikes. Always shut the power off before making connections.
3. Do not expose LEDs, controllers or other electronics to intense electro-magnetic fields, including lightning.
4. Our controllers, boosters, decoders and power supplies are generally not waterproof. Keep them dry.
5. Always observe proper polarity to avoid damaging components.
6. Supply the LED bars with 24 volts DC only. (24 volt AC systems will light the LEDs, but they will flicker and be dim because they only operate half of each cycle.)
7. If you use your own power supplies, be sure they are regulated. Some inexpensive wall wart supplies and other power supplies allow the voltage to go above the rated voltage in certain low-load situations.
8. It is a good idea to allow around 20-25% or more margin for safety with power supplies. This document explains how to build large scale systems—just be sure to buy enough hardware to get the job done.

When installing LED lighting, it is a good idea to follow this “dry-run” procedure:

1. Be sure you have everything you need before you start.
2. Lay out your lights, controller, power supply and any other required hardware on the floor or table.
3. There is some resistance in the LED lighting. If you see any color fading or dimming at the end of a long run, you may have too many LEDs for your power supply or controller. We usually recommend running no more than about 60 watt’s worth of LED under cabinet lighting in one branch. If you need to run more than that, you should split the run into sections. Call if you need assistance with larger projects. We can help you select the required power supplies.
4. Connect everything and test it to be sure it works and you have it connected properly. It is unlikely, but possible, that some part of your system is defective or was damaged during shipment. If that is the case, it will be very helpful to you to know that before you do all the work involved in installing it. You will also know if you damage anything during

installation, which is helpful in trouble-shooting because manufacturing defects and installation damage typically have very different solutions.

5. Damaged and previously installed strips are not returnable, so please call first if you have questions. Our customers have very few problems with our LED lights, as long as they follow the instructions and call if they have questions.

Once you have tested the system successfully, you are ready to install it.

## California Title 24

Compliance with California Title 24 depends on many things, including type of installation (commercial or residential), size of installation, measured in watts, type of driver used (dimming or not dimming, which influences driver efficiency,) and what the room is used for (closet, kitchen, bath, shop, etc.)

Also, the specifications of Title 24 change frequently.

The chart below provides efficacy of the under cabinet bars for the purposes of determining whether or not they comply with Title 24 according to the particular circumstances of your installation.

<b>Part #</b>	<b>Lumens</b>	<b>Watts</b>	<b>Lumens/Watt</b>
<b>Soft White</b>			
mod-t-sw12	190	3	63
mod-t-sw20	350	5	70
mod-t-sw40	680	11	62
mod-a-sw12	190	3	63
mod-a-sw20	350	5	70
mod-a-sw40	680	11	62
mod-puck-sw	190	3	63
<b>Neutral White</b>			
mod-t-nw12	200	3	67
mod-t-nw20	390	5	78
mod-t-nw40	780	11	71
mod-a-nw12	200	3	67
mod-a-nw20	390	5	78
mod-a-nw40	780	11	71
mod-puck-nw	200	3	67